

GROHE Blue® Professional Connected
DESIGN + ENGINEERING
GROHE GERMANY

INT00022/ÄM 242563/02.19















www.grohe.com

*Pure Freude
an Wasser*

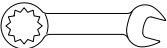

Legend	2
Safety information	3
Intended use	5
Operating conditions	5
Technical data	5
Apple	5
Android™	5
Current application	6
Function range	6
Connection settings	6
iOS	7
GROHE ONDUS app overview	7
Initial start-up	7
Installing the GROHE ONDUS app	7
Starting the GROHE ONDUS app	8
Adding the GROHE BLUE Professional cooler to the network	8
Operation	9
Checking the system status	9
Changing names/settings	9
Restore factory settings	10
Logging out	10
Messages	10
Android	11
GROHE ONDUS app overview	11
Initial start-up	11
Installing the GROHE ONDUS app	11
Starting the GROHE ONDUS app	12
Adding the GROHE BLUE Professional cooler to the network	12
Operation	13
Checking the system status	13
Changing names/settings	13
Restore factory settings	14
Logging out	14
Messages	14
Maintenance	15
Faults	15

Legend

	Information
	General information
	Operation
	Settings
	Scope of delivery
	Not included in scope of delivery
	Shut off water supply
	Check watertightness
	Caution!
	Use force
	Factory setting
	Cleaning
	Assembly
	Maintenance
	Add cooler to the network



Safety information

Hazard warnings:

- Avoid any danger resulting from damaged connection cables. In the case of damage, the connection cable must be replaced by the manufacturer or its customer service department or an equally qualified person.

Installation instructions:

- The device must only be installed in frost-proof rooms.
- Installation must be carried out by a trained professional installer.
- The water supply must be shut off before installation.
- The installation and use of the GROHE Blue Professional is subject to the applicable national regulations.

Operation instructions:

- The water to be used must comply with the European Drinking Water Directive. The manufacturer must be consulted before the device can be used with water of a different quality or containing additives.
- GROHE Blue Professional may only be used as described in the operating instructions. Any other usage or usage extending beyond that described is deemed improper use.
- GROHE Blue Professional must only be used in good order and condition, as intended and in a safety-conscious and hazard-aware manner, with due regard to the operating instructions.
- Malfunctions must be immediately rectified.
- No liability is assumed for damage owing to non-compliance with the operating instructions.
- Use **only genuine spare parts and accessories**. The use of other parts will void the warranty and the CE marking and could also cause injury.

Notes on software and Internet connection:

- In order to ensure the device operates with full functionality, both the smartphone used and GROHE Blue Professional cooler must be connected to the Internet, and the device must have been installed successfully via the GROHE ONDUS app beforehand. Otherwise, the device will not be configured and no notifications can be sent.
- GROHE recommends familiarising yourself with the product and the app functions **before installing** GROHE Blue Professional. The Wi-Fi reception range should also be tested in the room in which the installation is carried out.
- GROHE takes all necessary measures to ensure safe and correct use. In the event of a malicious attack by third parties, GROHE advises installing the latest firmware and/or disconnect the device from the power supply grid until you receive further information from GROHE.

Intended use

The GROHE Blue Professional cooler is suitable for use in cold drinking water up to a maximum water temperature of 24 °C.



Operating conditions

In order to function properly, the GROHE Blue Professional cooler **must** be connected to a Wi-Fi network (2.4 GHz, IEEE 802.11b/g/n) **with continuous Internet access**. Only Wi-Fi channels 1 – 11 can be used. After successful connection to the Wi-Fi network, it is **not** possible to allocate the GROHE Blue Professional cooler to another Wi-Fi network during ongoing operation (RESET required).

Technical data

• Flow pressure	0.2 – 0.9 MPa
• Operating pressure	max. 1 MPa
• Test pressure	1.6 MPa
• Water temperature	max. 24 °C
• Ambient temperature	max. 35 °C
• Voltage supply	230 V~ / 50 Hz
• Power consumption	240 W

Electrical test data

• Software class	A
• Contamination class	2
• Rated surge voltage	2500 V
• The test for electromagnetic compatibility (interference emission test) was performed at the rated voltage and rated current.	

Apple:

- Operating system iOS 9.0 and higher

Android™:

- Operating system 4.3 and higher
- Recommended pixel density minimum 160 dpi
- Resolution minimum 320 x 470 pixels

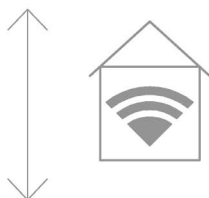

Current application

The latest version of the required app (GROHE ONDUS) must be installed on the smartphone; see Initial installation.

Function range

- Preparing and drawing drinking water
- Status information on filter and CO₂ cylinder consumption

Connection settings

- The GROHE Blue Professional cooler must be connected to a Wi-Fi network with continuous Internet access
- For the GROHE Blue Professional cooler password: see nameplate or sticker front cover.
- **Internet access must be permanently enabled** on the smartphone
(Settings / mobile data / on)
- The GROHE Blue Professional cooler must be registered in the GROHE ONDUS app

When operating under unfavourable ambient conditions, in rooms with reinforced concrete walls, steel or iron frames or in the vicinity of obstacles (e.g. furniture) made of metal, Wi-Fi reception can be impaired and interrupted.

Type of barrier	Interference or screening potential
Wood, plastic, glass	Low
Water, bricks, marble	Medium
Plaster, concrete, solid wood	High
Metal	Very high

The GROHE Blue cooler operates in the 2.4 GHz frequency band.

Installation in the vicinity of devices with the same frequency band (e.g. DECT telephones, Bluetooth devices etc. [observe manufacturer documentation!]) should be avoided.

In the absence of a Wi-Fi connection, the GROHE Blue Professional can also be operated using the buttons on the faucet and cooler.

However, without a Wi-Fi connection, push notifications cannot be sent to the connected smartphone. The push notification is dispatched as soon as the Wi-Fi connection is restored.

iOS

GROHE ONDUS app overview

Main screen (dashboard)

- Selection bar for administering connected houses
- Selection bar for administering connected rooms and to detect or configure linked products
- Information on using the app:

Swipe from left to right:
Product catalogue

Swipe from right to left:
Overview of integrated products

Tap Menu or swipe from bottom to top:
Menu overview (My Houses, Settings, Order Products, Help & Support, Legal and Logout)

Return to the previous screen swiping in the opposite direction or by tapping BACK or HOME.

Initial start-up

Activate Wi-Fi on the smartphone and ensure permanent access to the Internet.

Installing the GROHE ONDUS app

GROHE ONDUS app is free from the Apple App Store (an Apple account is required).



Important note:

To ensure that the warnings and alarms can be received as messages on the smartphone, the appropriate service for receiving push notifications must be activated for the GROHE ONDUS app.

Push notifications can only be received on the smartphone if the user is logged into the app.

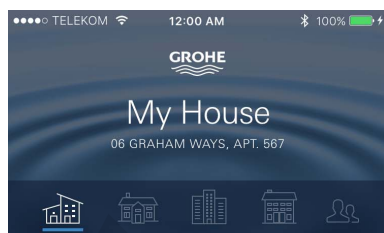

MY GROHE BLUE



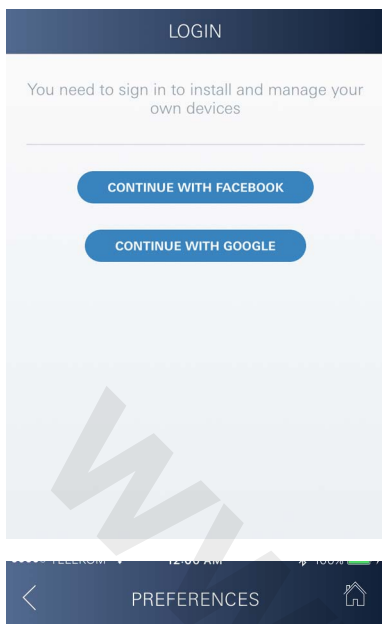

Starting the GROHE ONDUS app

Tap the app icon to start the application.

Login and registration:

- Using an existing Google or Facebook account
- By creating a new Google or Facebook account
- Using a GROHE account
- To use the GROHE ONDUS app, you must accept the terms and conditions of use.
- Connection to the cloud is established automatically
- The main screen (dashboard) is shown

Adding the GROHE BLUE Professional cooler to the network

Follow the instructions in the app.

1. Select the appropriate device from the catalogue.
2. Give the device a name.
(Caution: Do not use special characters!)
3. Select / create a new house.
(Enter address and contact information.
Caution: Do not use special characters!)
4. Select / create a new room.
5. Enter the hose length.
(Without an extension set [order no. 40 843], this value is pre-set to 110 cm)
6. Set the water hardness.
7. Select the filter type.
8. On the GROHE Blue Professional cooler activate the access point.

Important note:

The configuration mode remains active for a maximum of 5 minutes.

9. On the smartphone, go to the Wi-Fi settings.
10. Select and connect the GROHE Blue Professional network.
SSID: GROHE_BLUE_xxxxxxx
For the GROHE Blue Professional cooler password: see nameplate or sticker on front cover.
11. Return to the GROHE ONDUS app and connect GROHE Blue Professional cooler to the private Wi-Fi network (the Wi-Fi network must have active Internet access at all times).
12. Enter and confirm the Wi-Fi password.
13. SETUP SUCCESSFUL is shown on successful connection.

The GROHE Blue Professional cooler is now registered in the GROHE ONDUS app and is connected to the cloud.

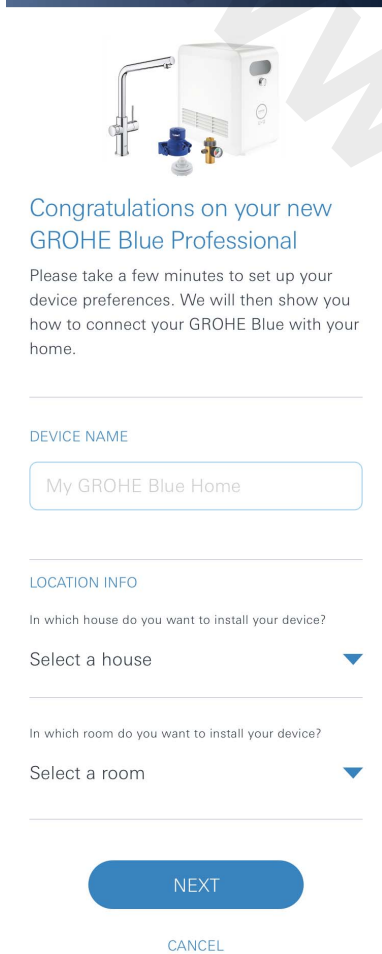

The CO₂ and residual filter capacity is measured and updated in the GROHE ONDUS app on a regular basis.

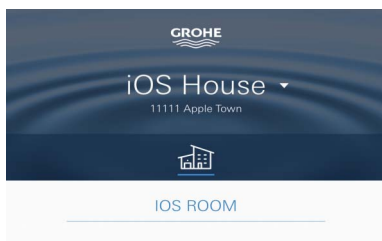

Operation

Drawing water with the GROHE BLUE Professional

1. Select the desired quantity.
2. Select the desired flavour (still, medium, sparkling).
3. Press Start.

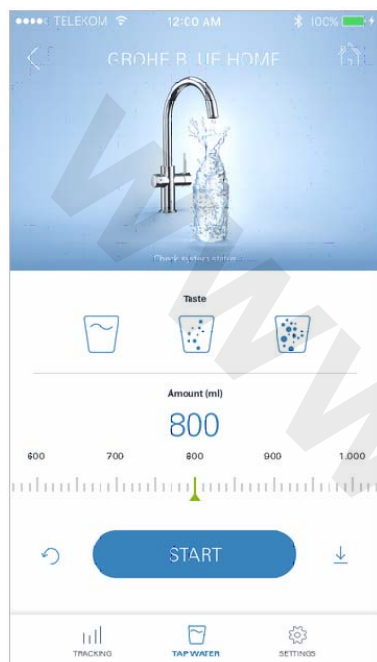

Checking the system status

1. Tap Settings/System Status
2. Tap the faucet above the water drawing settings



Changing names/settings

1. Tap Menu or swipe from bottom to top.
2. Select the menu option MY HOUSES.
Here you can edit, delete or add houses, address data and rooms.
3. Select the required menu option.

Note

Any changes to names/settings are transferred immediately to the cloud.

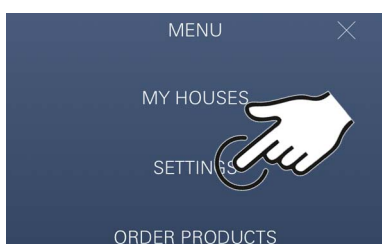

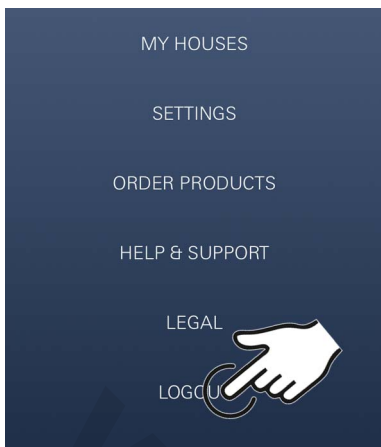

Restore factory settings

- On GROHE Blue Professional cooler via menu Reset factory settings.

Logging out

1. Tap Menu or swipe from bottom to top.
2. Tap LOGOUT.
3. Close the GROHE ONDUS app.

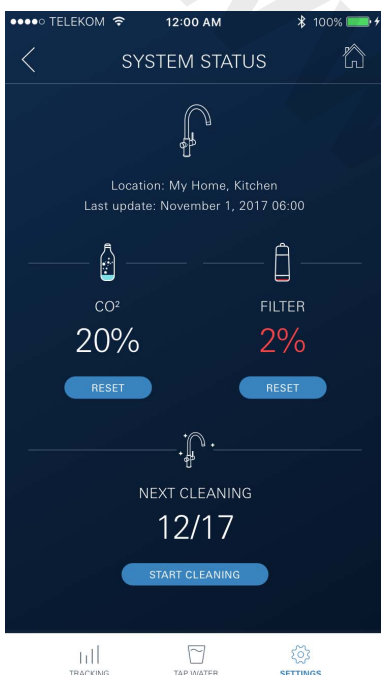
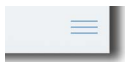

Messages

Critical consumption values of CO₂ and residual filter capacity are displayed as a message within the ONDUS app and sent via push notification to the connected smartphones.

If the app or the device firmware requires updating, the smartphone must be located in the immediate vicinity of the GROHE Blue Professional cooler. This allows potential interruptions in function to be controlled and rectified.

Important note:

Push notifications must be activated for the GROHE ONDUS app on the smartphone.

Push notifications can only be received on the smartphone if the user is logged into the app.

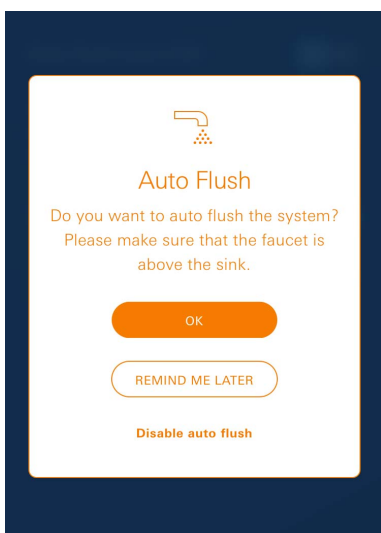

Android

GROHE ONDUS app overview

Main screen (dashboard)

- Selection bar for administering connected houses
- Selection bar for administering connected rooms and to detect or configure linked products
- Information on using the app
Swipe from left to right:
Product catalogue
- Information on using the app
Swipe from right to left:
Overview of integrated products
- Information on using the app
Swipe from bottom to top:
Menu overview (My Houses, Settings, Order Products, Help & Support, Legal and Logout)

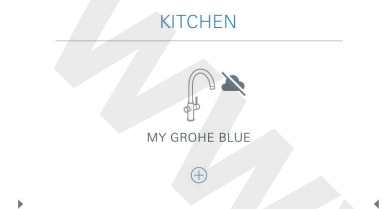

Return to the previous screen by tapping BACK or HOME.

Initial start-up

Activate Wi-Fi on the mobile end device and ensure permanent access to the Internet.



Installing the GROHE ONDUS app

GROHE ONDUS app is free from the Google Play Store (a Google account is required).

Important note:

To ensure that the warnings and alarms can be received as messages on the smartphone, the appropriate service for receiving push notifications must be activated for the GROHE ONDUS app.

Push notifications can only be received on the smartphone if the user is logged into the app.



Starting the GROHE ONDUS app

Tap the app icon to start the application.

Login and registration:

- Using an existing Google or Facebook account
- By creating a new Google or Facebook account
- Using a GROHE account
- To use the GROHE ONDUS app, you must accept the data protection statement
- Connection to the cloud is established automatically
- The main screen (dashboard) is shown

Adding the GROHE BLUE Professional cooler to the network

Follow the instructions in the app.

1. Select the appropriate device from the catalogue.
2. Give the device a name.
(Caution: Do not use special characters!)
3. Select / create a new house.
(Enter address and contact information.
Caution: Do not use special characters!)
4. Select / create a new room.
5. Enter the hose length.
(Without an extension set [order no. 40 843], this value is pre-set to 110 cm)
6. Set the water hardness.
7. Select the filter type
8. On the GROHE Blue Professional cooler activate the access point.

Important note:

The configuration mode remains active for a maximum of 5 minutes.

9. On the smartphone, go to the Wi-Fi settings.
10. Select and connect the GROHE Blue Professional network.
SSID: GROHE_BLUE_xxxxxxx
For the GROHE Blue Professional cooler password: see nameplate or sticker on front cover.
11. Return to the GROHE ONDUS app and connect GROHE Blue Professional cooler to the private Wi-Fi network (the Wi-Fi network must have active Internet access at all times).
12. Enter and confirm the Wi-Fi password.
13. SETUP SUCCESSFUL is shown on successful connection.

The GROHE Blue Professional cooler is now registered in the GROHE ONDUS app and is connected to the cloud.

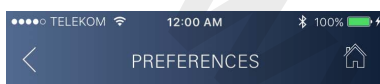

Congratulations on your new GROHE Blue Professional

Please take a few minutes to set up your device preferences. We will then show you how to connect your GROHE Blue with your home.

DEVICE NAME

My GROHE Blue Home

LOCATION INFO

In which house do you want to install your device?

Select a house

In which room do you want to install your device?

Select a room

NEXT

CANCEL

The CO₂ and residual filter capacity is measured and updated in the GROHE ONDUS app on a regular basis.



Operation

Drawing water with the GROHE BLUE Professional

1. Select the desired quantity.
2. Select the desired flavour. (still, medium, sparkling)
3. Press Start.

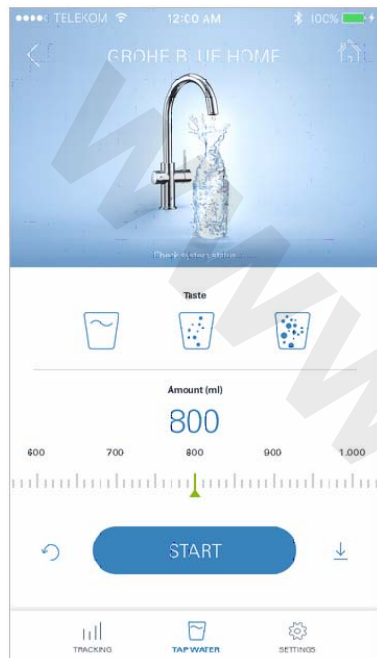

Checking the system status

1. Tap Settings/System Status.
2. Tap the faucet above the water drawing settings.



Changing names/settings

1. Tap Menu or swipe from bottom to top.
2. Select the menu option MY HOUSES. Here you can edit, delete or add houses, address data and rooms.
3. Select the required menu option.

Note

Any changes to names/settings are transferred immediately to the cloud.

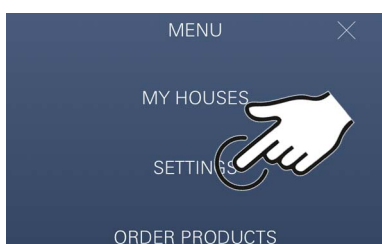

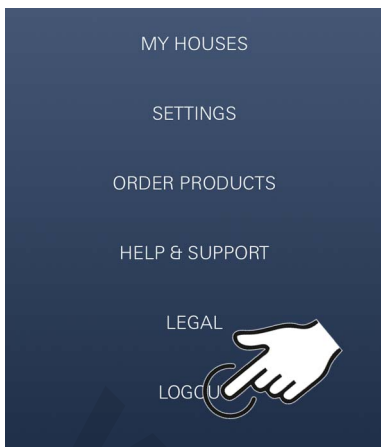

Restore factory settings

- On GROHE Blue Professional cooler via menu Reset factory settings.

Logging out

1. Tap Menu or swipe from bottom to top.
2. Tap LOGOUT.
3. Close the GROHE ONDUS app.

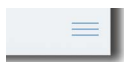

Messages

Critical consumption values of CO₂ and residual filter capacity are displayed as a message within the ONDUS app and sent via push notification to the connected smartphones.

If the app or the device firmware requires updating, the smartphone must be located in the immediate vicinity of the GROHE Blue Professional cooler. This allows potential interruptions in function to be controlled and rectified.

Important note:

Push notifications must be activated for the GROHE ONDUS app on the smartphone.

Push notifications can only be received on the smartphone if the user is logged into the app.

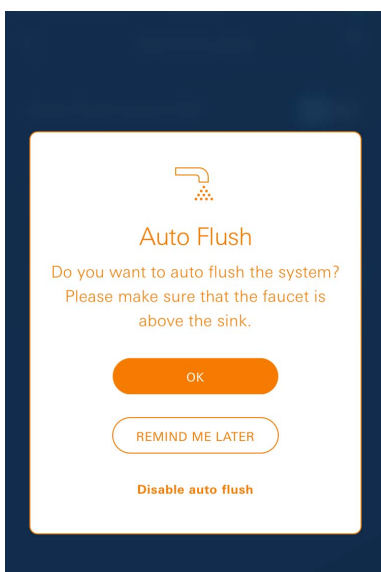
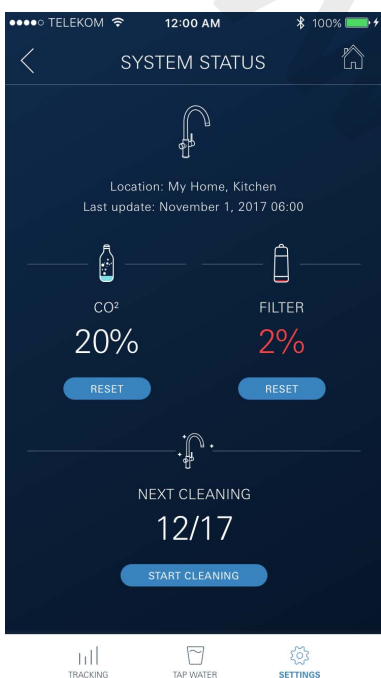





Maintenance

The filter cartridge and CO₂ cylinder must be changed when directed by the display on the display of the GROHE BLUE Professional cooler or the ONDUS app.

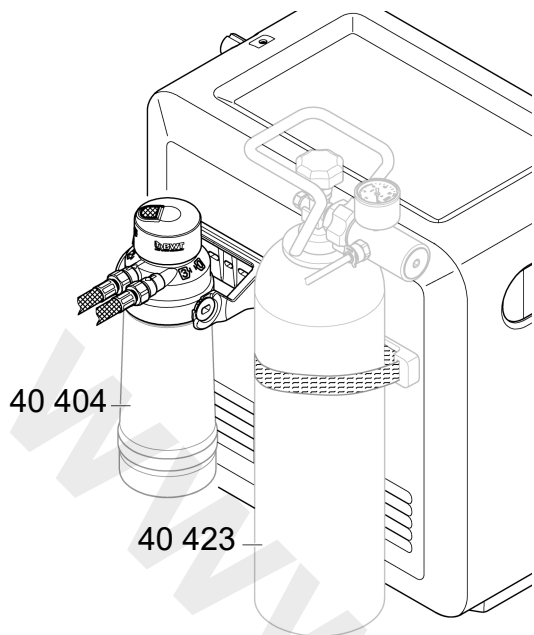
Once the residual filter capacity or the CO₂ cylinder has been used up, it will no longer be possible to draw the water types.
(still, medium, sparkling)

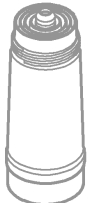
For reasons of hygiene, the cooler/carbonator must be cleaned twice a year. You must clean the device before changing the filter cartridge.

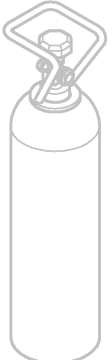

	40 404 (S-Size)		40 422 (CO ₂ cylinder)
	40 430 (M-Size)		
	40 412 (L-Size)		
	40 547 (AC)		
	40 575(UltraSafe)		
	40 691 (Mg+)		
	40 434 (Xtra Clean)		

Faults

Faults in the system are displayed by the handle blinking, checking the cooler or as a notification in the app.

A fault can have several causes.

The following table (page 16) indicates possible causes.

All indicated causes must be checked.

If none of the measures allows the error message to be rectified, a professional installer must remedy the issue.

Servicing

Fault ?	Cause !	Remedy ✓
Water not flowing	<ul style="list-style-type: none"> • Filter not installed correctly • Hoses kinked • Water supply interrupted 	<ul style="list-style-type: none"> - Insert the filter straight (1¹/₂ – 2 turns) - Check hoses for kinks - Open stop valves fully
E1 on display, no filtered water, Blue® handle flashing red	<ul style="list-style-type: none"> • Pump safety shut-off device 	<ul style="list-style-type: none"> - Disconnect voltage supply, wait 30 seconds and reconnect * - Insert the filter straight (1¹/₂ – 2 turns) - Check hoses for kinks - Open stop valves fully
E3 on display, no filtered water	<ul style="list-style-type: none"> • No connection between faucet and cooler/carbonator • Cable or connector defective 	<ul style="list-style-type: none"> - Connect plug-in connector * - Contact GROHE customer service
E5 on display, no filtered water, Blue® handle flashing red	<ul style="list-style-type: none"> • Fault function of cooler/carbonator 	<ul style="list-style-type: none"> - Disconnect voltage supply, wait 30 seconds and reconnect *
E7 on display, Blue® handle flashing red	<ul style="list-style-type: none"> • Humidity detected inside the cooler 	<ul style="list-style-type: none"> - Disconnect voltage supply, wait 15 minutes and reconnect * • If condensation, the cooler is ready for operation after that • If leakage occurs, the error message occurs again and the GROHE customer service must be contacted
E8 on, Blue® handle flashing orange	<ul style="list-style-type: none"> • Filter capacity exceeded 	<ul style="list-style-type: none"> - Change filter cartridge immediately
E9 flashing alternately with HI on display	<ul style="list-style-type: none"> • Cooler/carbonator overheated 	<ul style="list-style-type: none"> - Close Blue® handle, ensure ventilation and reduce ambient temperature to max. 32 °C - Let the cooler cool down for at least 10 – 15 min - Reset E9 error message, see below
EC on display, Blue® handle flashes white	<ul style="list-style-type: none"> • CO₂ cylinder almost empty or not in place 	<ul style="list-style-type: none"> - Replace CO₂ cylinder or put back in place
No carbon dioxide in positions Medium and Sparkling	<ul style="list-style-type: none"> • CO₂ cylinder empty 	<ul style="list-style-type: none"> - Replace CO₂ cylinder
* If errors E1 to E7 occur three or more times, please contact GROHE customer service		

Service Ondus app

Fault ?	Cause !	Remedy ✓
Login/registration not possible	<ul style="list-style-type: none"> • No GROHE account available • Not logged in to Google or Facebook account 	<ul style="list-style-type: none"> - Log in using a new GROHE account - Log in using an existing Google or Facebook account
Access point (Wi-Fi) of the GROHE Blue Professional cooler is not visible	<ul style="list-style-type: none"> • Configuration mode / access point not activated 	<ul style="list-style-type: none"> - Activate Wi-Fi on the smartphone and ensure permanent access to the Internet. If only other wireless networks are shown, contact GROHE customer service
Integration has failed	<ul style="list-style-type: none"> • The GROHE Blue Professional cooler is out of the range of reception 	<ul style="list-style-type: none"> - Change the location of the router - Use a Wi-Fi repeater